

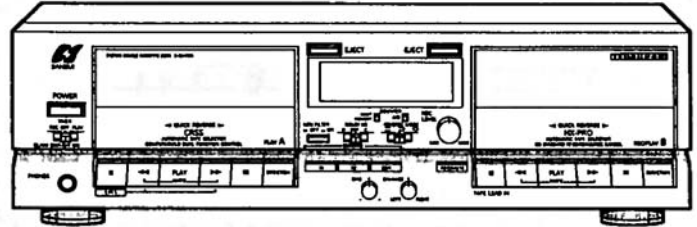

SERVICE MANUAL

D-X311WR

STEREO DOUBLE
CASSETTE DECK



CAUTION

1. Parts identified by the Δ symbol on the schematic diagram and the parts list are critical for safety. Use only replacement parts that have critical characteristics recommended by the manufacturer.
2. Make leakage-current or resistance measurements to determine that exposed parts are acceptably insulated from the supply circuit before returning the appliance to the customer.

NOTE

The symbols UL, CSA, UK, EU, SEV, SS and XX <EXPORT> on the parts list and the schematic diagram mean followings respectively.

UL Manufactured for U.S.A. market.
(Underwriters Laboratories approved model.)
CSA Manufactured for Canadian market.
UK Manufactured for United Kingdom market.
EU Manufactured for European market.
(Except United Kingdom and Swiss market.)

SEV Manufactured for Swiss market.
SS Manufactured for Saudi Arabian market.
XX Standard Version.
<EXPORT>
NON MARK ... Common Parts.

Specifications

Track format 4-track/2-channel system

Tape speed 4.8 cm/sec

Heads

Rec/play head Hard permalloy

Play head Hard permalloy

Erase head Double-gap ferrite

Motor Capstan: Electronically controlled
DC motor x2

Reels: DC motor x2

Wow/flutter 0.06 % max (WRMS)

Fast forwarding (rewinding) time

..... Approx. 100 sec. (for C-60 tape)

Frequency response (-20 VU recording/playback)

Normal tape (LH) 20 to 18,000 Hz
(20 to 17,000 Hz \pm 3 dB)

Chrome tape 20 to 19,000 Hz
(20 to 18,000 Hz \pm 3 dB)

Metal tape 20 to 20,000 Hz
(20 to 19,000 Hz \pm 3 dB)

Signal-to-noise ratio (recording/playback with metal tape)

DOLBY NR OFF Better than 58 dB

DOLBY-B NR ON Better than 65 dB

DOLBY-C NR ON Better than 75 dB

Erasure rate (metal tape) More than 70 dB at 1kHz

Recording bias frequency 105 kHz

Input sensitivity/Impedance

LINE IN (REC) 70 mV / 40 kohms

Power requirements AC 120, 220, 240 V (50/60 Hz)

For U.S.A. & Canada AC 120 V, 60 Hz

Power consumption 22 watts

Dimensions 430 mm (16-15/16") W

125 mm (4-15/16") H

270 mm (10-11/16") D

Weight 4.6 kg (10.1 lbs) net

5.6 kg (12.3 lbs) packed

- * Design and specifications subject to changes without notice for improvements.
- * Due to local laws and regulations, this unit sold in some areas are not equipped with variable voltage selectors.
- * Dolby noise reduction and HX Pro headroom extension manufactured under license from Dolby Laboratories Licensing Corporation. HX Pro originated by Bang & Olufsen. "DOLBY", the double-D symbol (DD) and "HX PRO" are trademarks of Dolby Laboratories Licensing Corporation.

1. BLOCK DIAGRAM 1-1. Audio Section

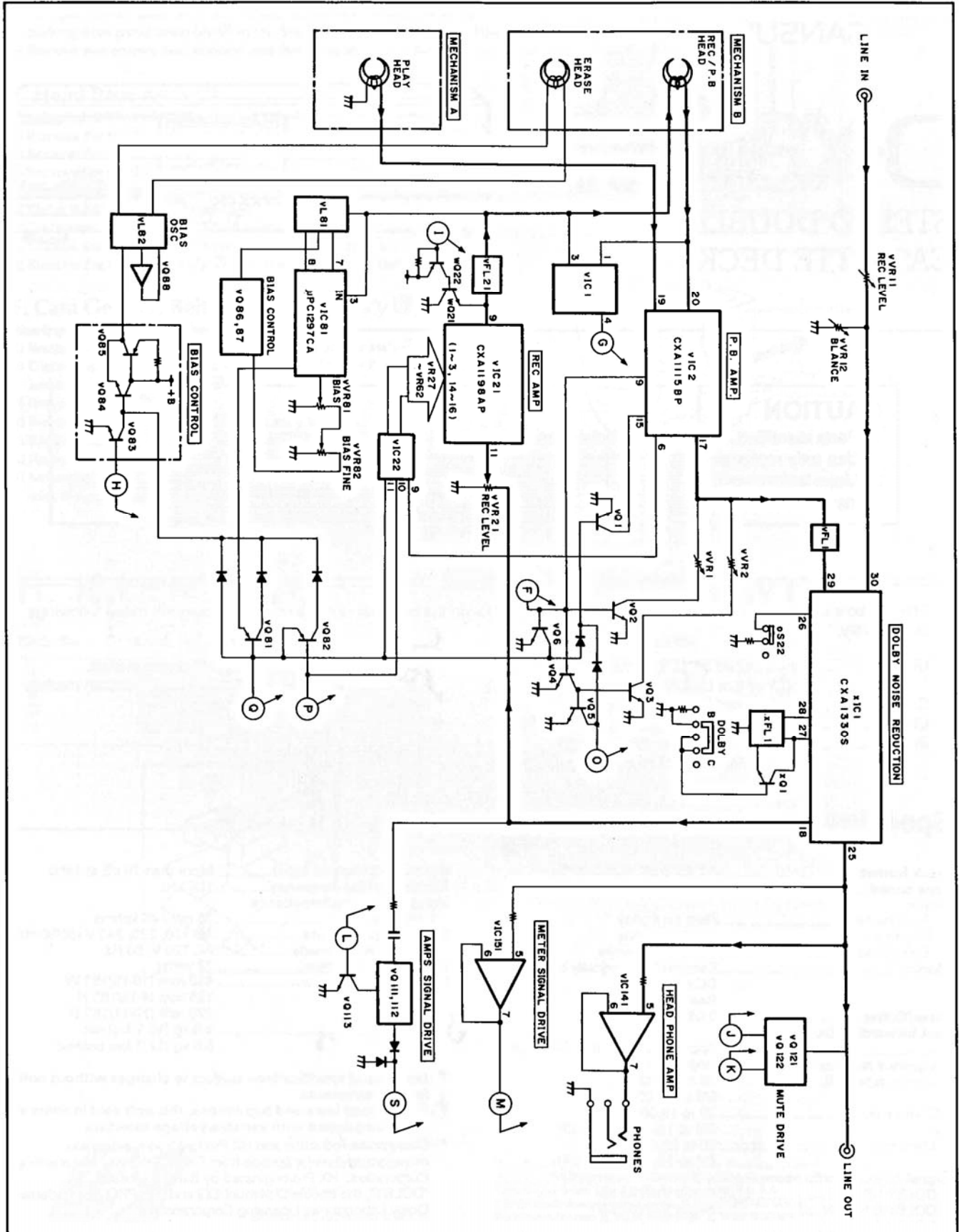

1-2. Control Section

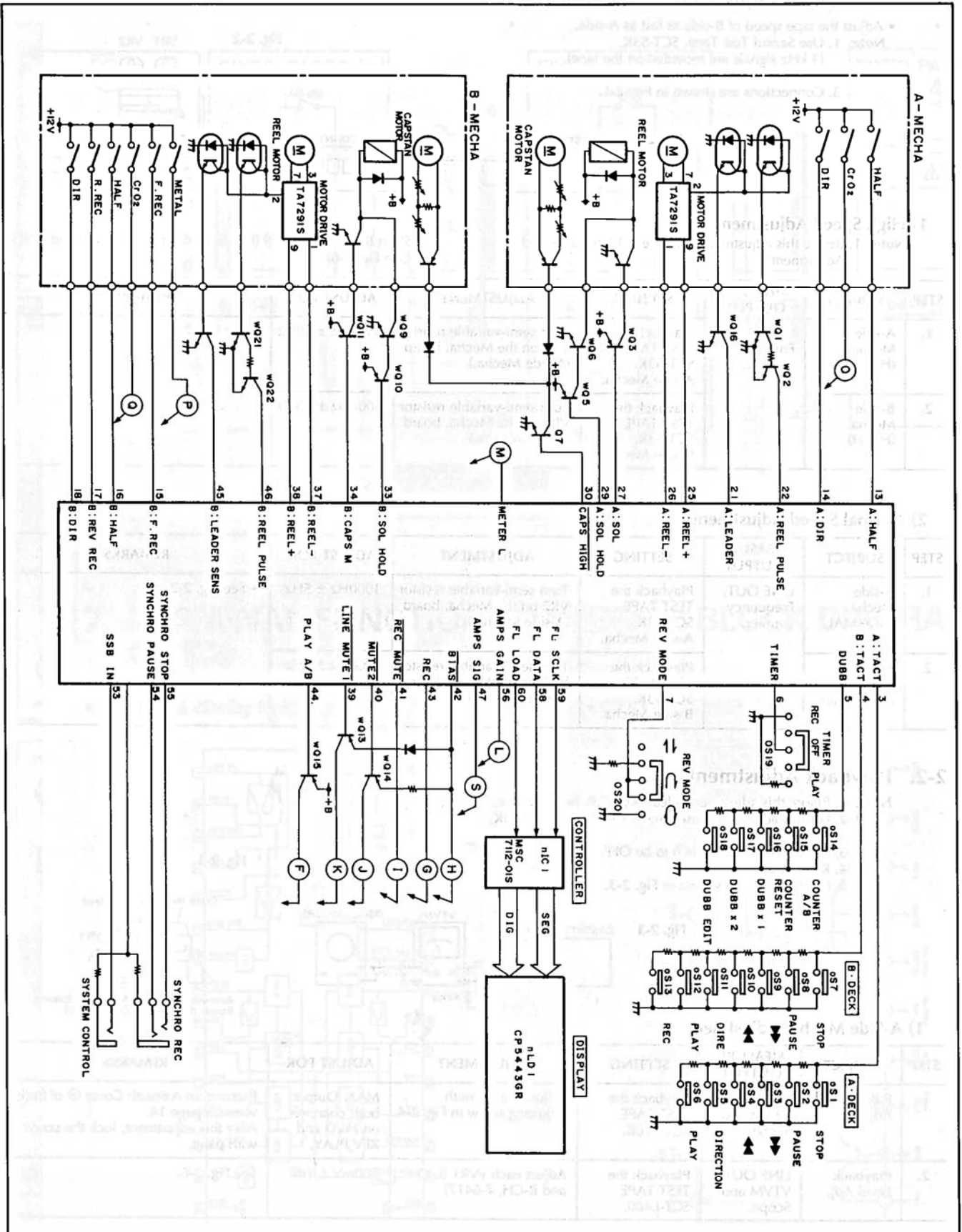

2. ADJUSTMENTS

2-1. Tape Speed Adjustment

- Adjust the tape speed of B-side as fast as A-side.
- Note:** 1. Use Sansui Test Tape, SCT-S3K.
(3 kHz signals are recorded on the tape).
- 2. Set the Timer Switch to be PLAY.
- 3. Connections are shown in Fig. 2-1.

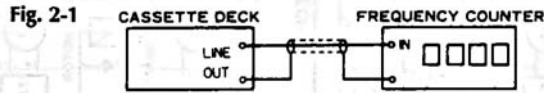
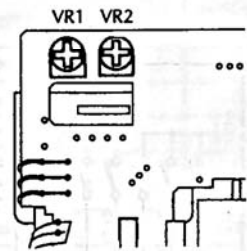

Fig. 2-2



1) High Speed Adjustment

Note: 1. Before this adjustment, regulate "1) Normal Speed Adjustment".

2. Short Between Point ⊙ (JW56) on the F-6417 board and GND. (See Fig. 2-6)

STEP	SUBJECT	MEASURE OUTPUT	SETTING	ADJUSTMENT	ADJUST FOR	REMARKS
1.	A-side Mecha. (HIGH)	LINE OUT, Frequency counter.	Playback the TEST TAPE SCT-S3K. A-side Mecha.	Turn semi-variable resistor VR1 on the Mecha. board (A-side Mecha.)	6000Hz ± 10Hz	• See Fig. 2-2.
2.	B-side Mecha. (HIGH)		Playback the TEST TAPE SCT-S3K. B-side Mecha.	Turn semi-variable resistor VR1 on the Mecha. board (B-side Mecha.)	6000Hz ± 10Hz	

2) Normal Speed Adjustment

STEP	SUBJECT	MEASURE OUTPUT	SETTING	ADJUSTMENT	ADJUST FOR	REMARKS
1.	A-side Mecha. (NORMAL)	LINE OUT, Frequency counter.	Playback the TEST TAPE SCT-S3K. A-side Mecha.	Turn semi-variable resistor VR2 on the Mecha. board (A-side Mecha.)	3000Hz ± 5Hz	• See Fig. 2-2.
2.	B-side Mecha. (NORMAL)		Playback the TEST TAPE SCT-S3K. B-side Mecha.	Turn semi-variable resistor VR2 on the Mecha. board (B-side Mecha.)	3000Hz ± 5Hz	

2-2. Playback Adjustment

- Note:** 1. Before this adjustment, clean REC/P.B. head surface.
2. For this adjustment, use Sansui Test Tape, SCT-F10K, and SCT-L400.
3. Set the Dolby NR switch to be OFF.
4. Remove the Lid Ass'y.
5. Connections are shown in Fig. 2-3.

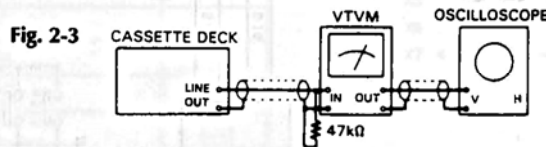
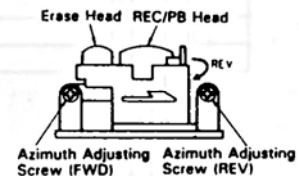

Fig. 2-4



1) A-Side Mecha. Adjustment

STEP	SUBJECT	MEASURE OUTPUT	SETTING	ADJUSTMENT	ADJUST FOR	REMARKS
1.	P.B. Head Adj.	LINE OUT, VTVM and Scope.	Playback the TEST TAPE SCT-F10K.	Adjust the azimuth adjusting screw in Fig. 2-4.	MAX. Output both channels on FWD and REV PLAY.	Remove an Azimuth Cover ⊙ of front view on page 14. After this adjustment, lock the screw with paint.
2.	Playback Level Adj.	LINE OUT, VTVM and Scope.	Playback the TEST TAPE SCT-L400.	Adjust each vVR1 (L-CH and R-CH, F-6417)	500mV ± 1dB	See Fig. 2-6.

2) B-Side Mecha. Adjustment

STEP	SUBJECT	MEASURE OUTPUT	SETTING	ADJUSTMENT	ADJUST FOR	REMARKS
1.	REC/P.B. Head Adj.	LINE OUT, VTVM and Scope.	Playback the TEST TAPE SCT-F10K.	Adjust the azimuth adjusting screw in Fig. 2-4.	MAX. Output both channels on FWD and REV PLAY.	Remove an Azimuth Cover ① of front view on page 14. After this adjustment, lock the screw with paint.
2.	Playback Level Adj.	LINE OUT, VTVM and Scope.	Playback the TEST TAPE SCT-L400.	Adjust each vVR2 (L-CH and R-CH, F-6417)	500mV ± 1dB	See Fig. 2-6.

2-3. Bias Adjustment

- Note: 1. BIAS control volumeCenter click position. 4. DOLBY NR switchOFF
 2. BALANCE control volumeCenter click position. 5. MPX FILTER switchOFF
 3. REC LEVEL volumeMax.

STEP	SUBJECT	MEASURE OUTPUT	SETTING	ADJUSTMENT	ADJUST FOR	REMARKS
1.	Bias Frequency Adj.	Between Point ① of JP5 and GND AC Volt Meter and Frequency counter.	1. Load the TEST TAPE SCT-MA 2. Push the REC and PLAY button.	Turn the core of vL82 (F-6417)	105kHz ± 1kHz	See Fig. 2-6.
2.	Dolby HX Trans. Adj.	Between TEST Point (TP +, TP -) vR89 AC Volt Meter.	Same as above.	Turn the core of vL81 (L-CH, R-CH)	Min. output	See Fig. 2-6.

2-4. REC Level & Frequency Response Adjustment

- Note: 1. Connections are shown in Fig. 2-5.
 2. Set the Dolby NR switch to be OFF.
 3. REC Level volumeMax.
 4. BIAS control volumeCenter click position.
 5. BALANCE control volumeCenter click position.

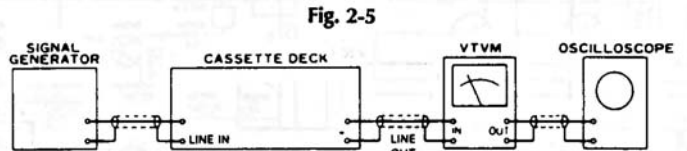

STEP	SUBJECT	MEASURE OUTPUT	SETTING	ADJUSTMENT	ADJUST FOR	REMARKS
1.	REC Level Adj.	Feed 1kHz, 50mV from S.G. into LINE IN.	LINE OUT, AC Volt Meter and Scope.	Load the TEST TAPE SCT-SA. 1. Record the 1kHz signal. 2. Confirm that output terminal level. 3. Playback the 1kHz signal.	Adjust vVR21 (L-CH and R-CH, F-6417) until playback level and output signal level on recording operation will be equal.	See Fig. 2-6.
2.	Frequency Response Adj.	Feed 1kHz 7mV and 12.5kHz 7mV from S.G. into LINE IN.	LINE OUT, AC Volt Meter and Scope.	Load the TEST TAPE SCT-SA. 1. Record the 1kHz and 12.5kHz signals from S.G. 2. Playback the 1kHz and 12.5kHz signals, then confirm 12.5kHz signal level in less than 1kHz signal level ± 3dB on AC Volt Meter.	1. If not, adjust vVR81 (L-CH and R-CH, F-6417) slightly until the 12.5kHz signal level in less than 1kHz signal level ± 3dB on AC Volt Meter.	See Fig. 2-6.

◆ List of Sansui Test Tape

Name of TEST TAPE	Recorded Frequency	Description	Equivalent To
SCT-F40	40 Hz	Playback Frequency Response Check	—
SCT-F1K	1 kHz	High Frequency Equalization Check	—
SCT-F10K	10 kHz	REC/PB Head Adjustment	—
SCT-L400N	400 Hz	Playback Level and Indicator Level Adjustment	—
SCT-S3K	3 kHz	Speed Check and Wow & Flutter Check	—
*SCT-AD (NORMAL)	—	Recording Bias Adjustment	TDK AD
*SCT-SA (HIGH)	—	REC/PB Level Adjustment	TDK SA
*SCT-MA (METAL)	—	Frequency Response Check	TDK MA

•Note: Some reference tapes marked * are not supplied.
As these are equivalent to ones indicated above, please obtain these blank tapes on your side as possible.

Fig. 2-6 F-6417 Adjustment Points

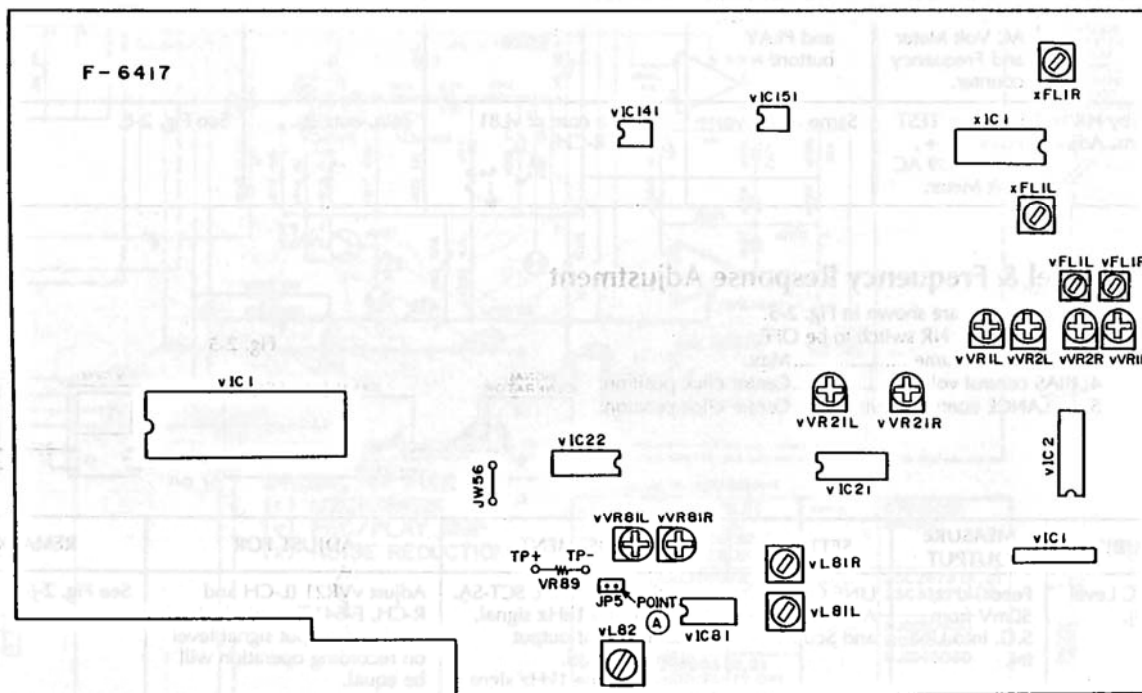

3. PARTS LIST OF BOARD

- Some printed circuit board are not supplied assembled. To separate these in this Parts list, the stock numbers are not indicated for these boards. However, stock numbers for individual parts are indicated.
- Since some capacitors and resistors are omitted from parts lists in this Parts List, refer to the Common Parts List for capacitors and resistors, which was issued on June 1987.
- Abbreviations in this Parts List are as follows.

•Abbreviations List

C.R.	: Carbon Resistor	E.B.	: Bi-Polar Electrolytic Capacitor
S.R.	: Solid Resistor	E.B.L	: Low Leak Bi-Polar Electrolytic Capacitor
Ce.R.	: Cement Resistor	F.C.	: Film Capacitor
M.R.	: Metal Film Resistor	M.P.	: Metalized Paper Capacitor
F.R.	: Fusing Resistor	P.C.	: Polystyrene Capacitor
N.I.R.	: Non-Inflammable Resistor	M.M.C.	: Metalized Mylar Capacitor
A.R.	: Array Resistor	A.C.	: Array Capacitor
C.C.	: Ceramic Capacitor	V.R.	: Variable Resistor
C.T.	: Ceramic Capacitor, Temperature Compensation	S.V.R.	: Semi Variable Resistor
E.C.	: Electrolytic Capacitor	SW.	: Switch
E.L.	: Low Leak Electrolytic Capacitor	Chip R.	: Chip Resistor
Ta.C.	: Tantalum Capacitor	Chip C.	: Chip Capacitor

3-1. F-6417 Main Board <Stock No. 01241201>

Parts No.	Stock No.	Description
•Transistor		
mQ1	03083901	2SD313HP
	or 49349400	2SD2012
mQ2	46367101	2SC2603
	or 46367301	2SC2458
	or 48058801	2SC1740S
mQ3	46367101	2SC2603
	or 46367301	2SC2458
	or 48058801	2SC1740S
mQ4	46367101	2SC2603
	or 46367301	2SC2458
	or 48058801	2SC1740S
mQ5	46581601	2SA992
mQ6	46367001	2SA1115
	or 46367201	2SA1048
	or 48058601	2SA933S
mQ7	46367001	2SA1115
	or 46367201	2SA1048
	or 48058601	2SA933S
•IC		
mIC1	07183500	μPC78M05H
	or 49440400	NJM78M05FA
•Diode		
mD1	48123600	11E2
mD2	48123600	11E2
mD3	48123600	11E2
mD4	48123600	11E2
mD5	46464100	1SS133
mD6	03117700	10E-2
mD7	03117700	10E-2
mD8	48123600	11E2
mD9	48123600	11E2
mD10	48123600	11E2
mD11	48123600	11E2
mD12	46464100	1SS133
•Zener Diode		
mDZ1	48555100	MTZ13A
	or 48634700	RD13B1
mDZ2	48637700	RD27B1
	or 48637800	RD27B2
	or 49516300	MTZJ27A
	or 49516400	MTZJ27B
mDZ3	48551200	MTZ3.9A
	or 48551300	MTZ3.9B

<F-6417>

Parts No.	Stock No.	Description
	or 48629500	RD3.9B
mDZ4	48552100	MTZ5.1B
	or 48630800	RD5.1B2
Δ mR11	46624300	100Ω 2W N.I.R.
oJ2	48985400	Jack, SYSTEM CONTROL
oJ3	49436400	Jack, SYNCHRO REC
oJ1	48528500	4P Terminal, LINE IN/OUT
•Transistor		
vQ1	46367101	2SC2603
	or 46367301	2SC2458
	or 48058801	2SC1740S
vQ2	46367101	2SC2603
	or 46367301	2SC2458
	or 48058801	2SC1740S
vQ3	46367101	2SC2603
	or 46367301	2SC2458
	or 48058801	2SC1740S
vQ4	46719900	DTC124ES
	or 49388200	RN1203
vQ5	46719900	DTC124ES
	or 49388200	RN1203
vQ6	46719900	DTC124ES
	or 49388200	RN1203
vQ21	46540801	2SC2878
	or 46604301	2SC3327
vQ22	46367001	2SA1115
	or 46367201	2SA1048
	or 48058601	2SA933S
vQ23	46719800	DTA124ES
	or 49390400	RN2203
vQ81	46367001	2SA1115
	or 46367201	2SA1048
	or 48058601	2SA933S
vQ82	46367001	2SA1115
	or 46367201	2SA1048
	or 48058601	2SA933S
vQ83	46367101	2SC2603
	or 46367301	2SC2458
	or 48058801	2SC1740S
vQ84	46367101	2SC2603
	or 46367301	2SC2458
	or 48058801	2SC1740S
vQ85	46614001	2SA1283
	or 48000801	2SA934

to be Continued

<F-6417>

Parts No.	Stock No.	Description
vQ86	46367101	2SC2603
	or 46367301	2SC2458
	or 48058801	2SC1740S
vQ87	49353500	DTB114ES
vQ88	46614101	2SC3243
	or 48000901	2SC2060
vQ111	46367101	2SC2603
	or 46367301	2SC2458
	or 48058801	2SC1740S
vQ112	46367101	2SC2603
	or 46367301	2SC2458
	or 48058801	2SC1740S
vQ113	46367101	2SC2603
	or 46367301	2SC2458
	or 48058801	2SC1740S
vQ121	46367101	2SC2603
	or 46367301	2SC2458
	or 48058801	2SC1740S
vQ122	46540801	2SC2878
	or 46604301	2SC3327
•IC		
vIC1	49323500	μPC1330HA
vIC2	49524000	CXA1115BP
vIC21	49362500	CXA1198AP
vIC22	49362200	TC4051BP
vIC81	49323400	μPC1297CA
vIC141	03607700	NJM4558D
	or 49263900	NJM2068D
	or 49541300	M5218AP
vIC151	03607700	NJM4558D
	or 49263900	NJM2068D
	or 49541300	M5218AP
•Diode		
vD1	46464100	1SS133
vD2	46464100	1SS133
vD21	46464100	1SS133
vD81	46464100	1SS133
vD82	46464100	1SS133
vD83	46464100	1SS133
vD111	46464100	1SS133
vD112	46464100	1SS133
vD151	46464100	1SS133
•Zener Diode		
vDZ1	48552700	MTZ6.2B
	or 48552800	MTZ6.2C
	or 48552900	MTZ6.8A
	or 48631600	RD6.2B2
	or 48631700	RD6.2B3
	or 48631900	RD6.8B1
vC3	48663200	330pF 50V C.C.
vC4	48663200	330pF 50V C.C.
vFL1	48366300	Trap Filter
vFL21	48363500	Trap Coil
vL81	49323600	Coil, Step Up
vL82	49323700	Coil, Bias OSC
vVR1	49367200	22kΩ S.V.R., P.B. Level (A-Mecha.)
vVR2	49367200	22kΩ S.V.R., P.B. Level (B-Mecha.)
vVR21	49367200	22kΩ S.V.R., REC Level Adj.
vVR81	49367300	47kΩ S.V.R., Bias
Δ vR19	46229500	270Ω 1/2W N.I.R.
Δ vR89	46227800	10Ω 1/2W N.I.R.

<F-6417>

Parts No.	Stock No.	Description
•Transistor		
wQ1	46367101	2SC2603
	or 46367301	2SC2458
	or 48058801	2SC1740S
wQ2	46367101	2SC2603
	or 46367301	2SC2458
	or 48058801	2SC1740S
wQ3	46719800	DTA124ES
	or 49390400	RN2203
wQ4	46719800	DTA124ES
	or 49390400	RN2203
wQ5	46719800	DTA124ES
	or 49390400	RN2203
wQ6	46359801	2SC2001
wQ7	46367101	2SC2603
	or 46367301	2SC2458
	or 48058801	2SC1740S
wQ9	46359801	2SC2001
wQ10	46719800	DTA124ES
	or 49390400	RN2203
wQ11	46719800	DTA124ES
	or 49390400	RN2203
wQ12	46719800	DTA124ES
	or 49390400	RN2203
wQ13	46719800	DTA124ES
	or 49390400	RN2203
wQ14	46719800	DTA124ES
	or 49390400	RN2203
wQ15	46719800	DTA124ES
	or 49390400	RN2203
wQ16	46719900	DTC124ES
	or 49388200	RN1203
wQ17	46719900	DTC124ES
	or 49388200	RN1203
wQ18	46367101	2SC2603
	or 46367301	2SC2458
	or 48058801	2SC1740S
wQ19	46367101	2SC2603
	or 46367301	2SC2458
	or 48058801	2SC1740S
wQ21	46367101	2SC2603
	or 46367301	2SC2458
	or 48058801	2SC1740S
wQ22	46367101	2SC2603
	or 46367301	2SC2458
	or 48058801	2SC1740S
•IC		
wIC1	49560100	TMP47C860N-P107
wXO1	49357500	Quartz Element
•Diode		
wD1	46464100	1SS133
wD2	46464100	1SS133
wD3	46464100	1SS133
wD4	46464100	1SS133
wD5	46464100	1SS133
wD6	46464100	1SS133
wD7	46464100	1SS133
wD8	46464100	1SS133
wD9	46464100	1SS133
•Zener Diode		
wDZ1	48552100	MTZ5.1B
	or 48630800	RD5.1B2
Δ wR27	46623900	47Ω 2W N.I.R.
Δ wR30	46623900	47Ω 2W N.I.R.

<F-6417>

Parts No.	Stock No.	Description
*Transistor		
xQ1	46367101	2SC2603
	or 46367301	2SC2458
	or 48058801	2SC1740S
xQ2	46367101	2SC2603
	or 46367301	2SC2458
	or 48058801	2SC1740S
*IC		
xIC1	49522700	CXA1330S
xC5	49522600	0.56μF 50V E.C.
xFL1	49370600	Dolby Filter

3-2. F-6418 Timer Switch Board

Parts No.	Stock No.	Description
oS19	46178400	Slide SW., TIMER

3-3. F-6420 Control Keys & Display Board

<Stock No. 01241601>

Parts No.	Stock No.	Description
*IC		
nIC1	49194500	MSC7112-01SS
nLD1	49537000	FL Display, CP5443GR
oS14	49326300	Push SW., COUNTER A/B
oS15	49326300	Push SW., COUNTER RESET
oS16	49326300	Push SW., DUBBING x 1
oS17	49326300	Push SW., DUBBING x 2
oS18	49326300	Push SW., DUBBING EDIT
oS20	46178400	Slide SW., REV. MODE
oS21	46178400	Slide SW., DOLBY-NR
oS22	46563500	Push SW., MPX FILTER
vVR11	49326400	50kΩ (B)x2 V.R., REC LEVEL
vVR12	49556100	100kΩ V.R., BALANCE
vVR82	49556000	10kΩ (B) V.R., BIAS

3-4. F-6421 A-Deck Function Keys Board

Parts No.	Stock No.	Description
oS1	49326300	Push SW., □
oS2	49326300	Push SW., ▢
oS3	49326300	Push SW., ▷
oS4	49326300	Push SW., ◀
oS5	49326300	Push SW., DIRECTION
oS6	49326300	Push SW., PLAY

3-5. F-6422 B-Deck Function Keys Board

Parts No.	Stock No.	Description
oS7	49326300	Push SW., □
oS8	49326300	Push SW., ▢
oS9	49326300	Push SW., ▷
oS10	49326300	Push SW., ◀
oS11	49326300	Push SW., DIRECTION
oS12	49326300	Push SW., PLAY
oS13	49326300	Push SW., REC/MUTE

3-6. F-6423 Head Phone Jack Board

Parts No.	Stock No.	Description
oJ4	49495100	Jack, PHONES

3-7. F-6424 Power Supply Primary Board

Parts No.	Stock No.	Description
Δ pC1	48733500	0.01μF 400V C.C.
Δ	or 49538100	0.01μF 400V C.C.

4. PARTS LOCATION ON BOARD

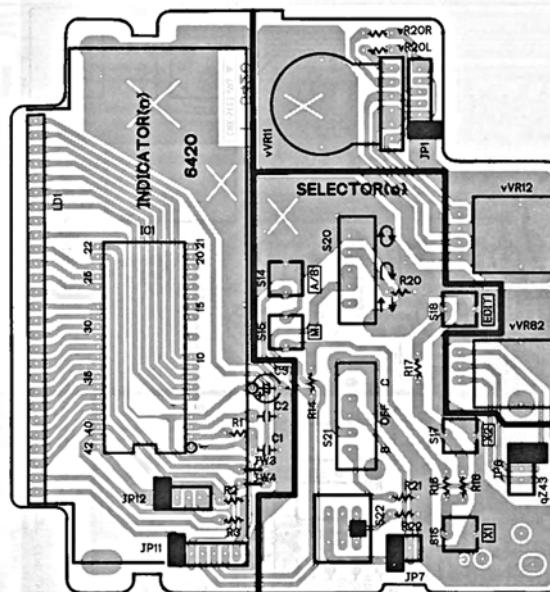
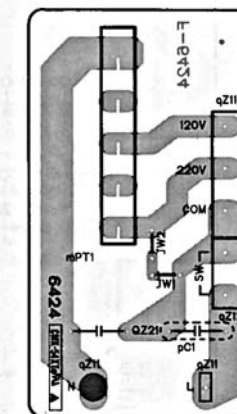
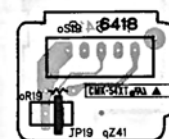
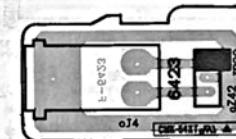
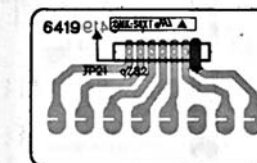
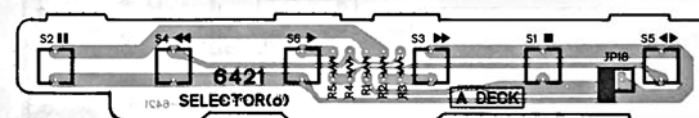
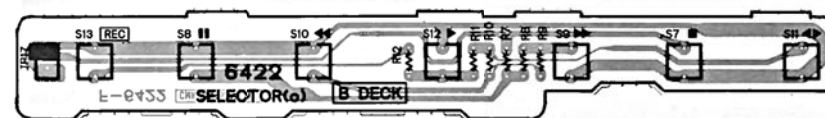
4-1. F-6420 Control Keys & Display Board
Component Side4-2. F-6424 Power Supply
Primary Board
Component Side4-3. F-6418 Timer Switch
Board
Component Side4-4. F-6423 Head Phone
Jack Board
Component Side4-5. F-6419 Connector
Board
Component Side4-6. F-6421 A-Deck Function Keys Board
Component Side4-7. F-6422 B-Deck Function Keys Board
Component Side

4-8. F-6417 Main Board
Component Side

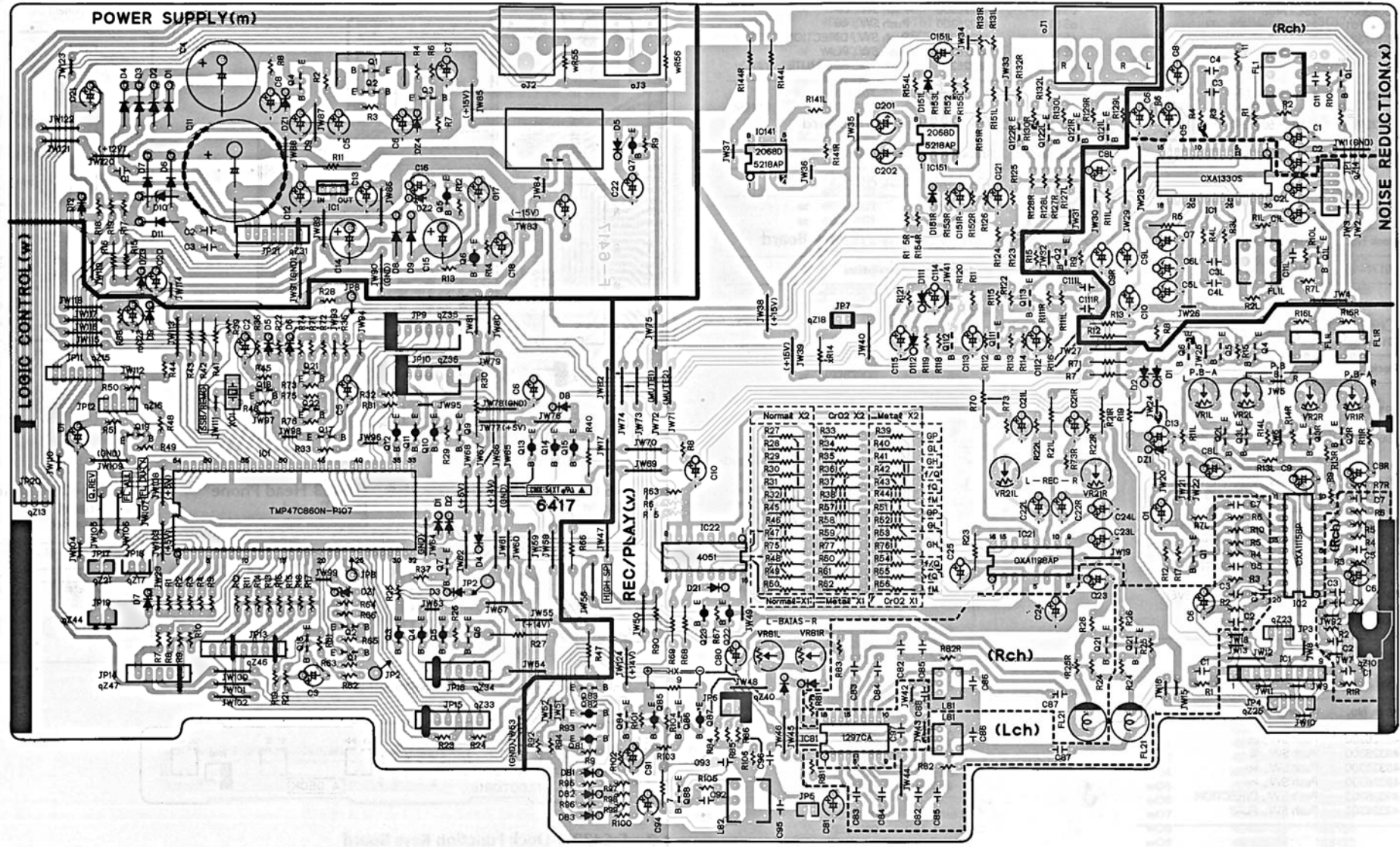

5. EXPLODED VIEW OF MECHANISM AND PARTS LIST

* Though every Part included in mechanism ass'y is numbered in exploded View, Parts Unlisted in parts list are not supplied.

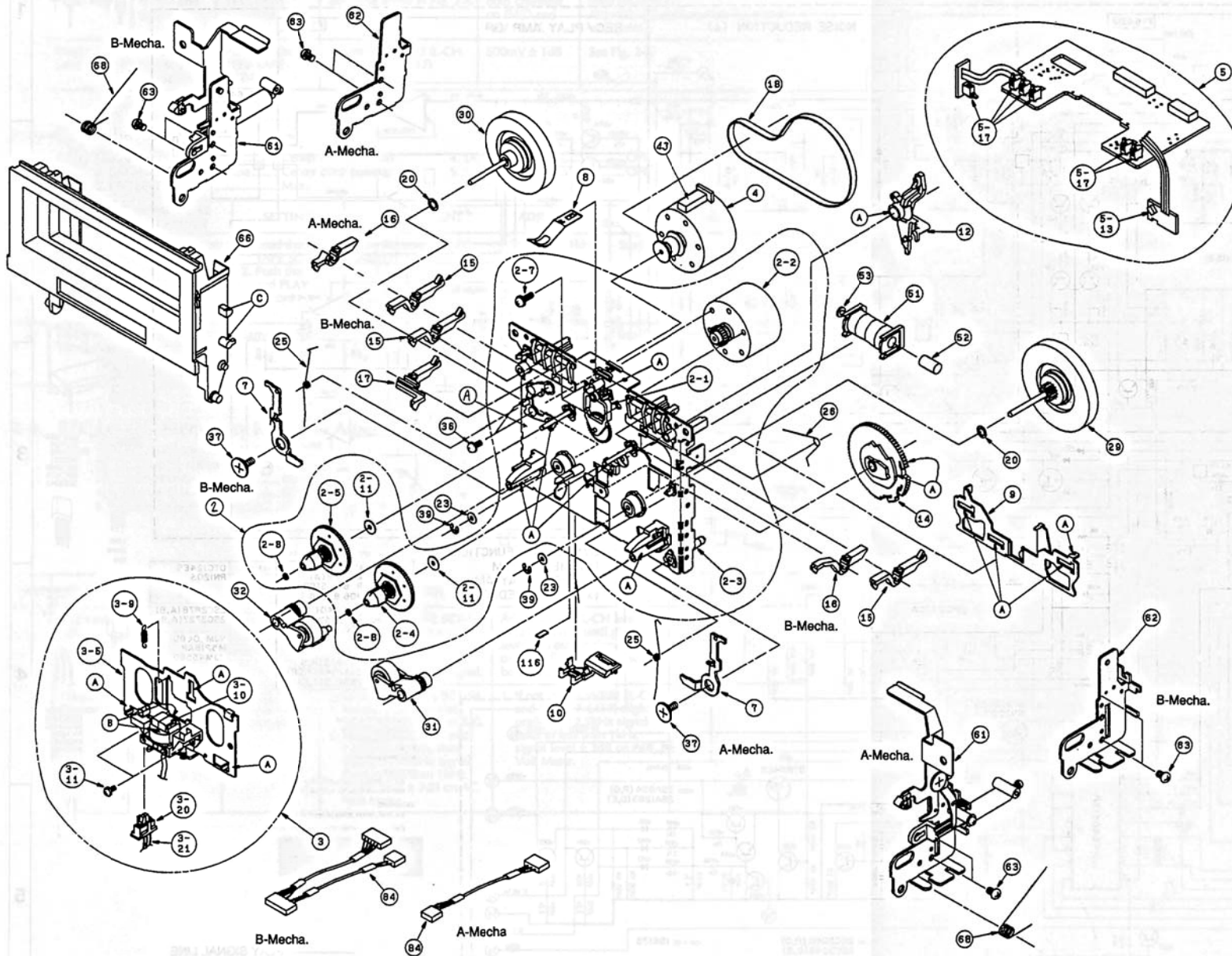

Parts No.	Stock No.	Description
2		Main chassis Ass'y
2-1	58731700	Idler Ass'y
2-2	58731800	Reel Motor Ass'y
2-3		Chassis Base Ass'y
2-4	58732000	Reel Base Ass'y R
2-5	58732100	Reel Base Ass'y F
2-7	58732200	M2.6x6.4 Pan. Head Screw
2-8	58732300	Slit Washer (1.7x0.25)
2-11	58732400	Thrust Washer (2.1x0.25)
3	58736900	Head Base Ass'y (A-Mecha.)
	58897800	Head Base Ass'y (B-Mecha.)
3-9	58733100	Spring, Head Base
3-10	58897900	Playback Head (A-Mecha.)
	58898000	Rec./Play/Erase, Head Ass'y (B-Mecha.)
3-11	58737200	M2x5 Pan. Tapping Screw
3-20	58891000	Photo Sensor SPI-320BC
3-21	58737400	QS Lead Wire
4	58898100	Motor Ass'y, Capstan
5	58898200	P.C.B. (Control), (A-Mecha.)
	58898300	P.C.B. (Control), (B-Mecha.)
5-13	58733900	Photo Sensor SPI-335-34-C
5-17	58734000	Push switch
8	58898500	Cassette Hold Spring (A-Mecha.)
	58734200	Cassette Hold Spring (B-Mecha.)
10	58738000	Lead Holder
12	58734300	Play Arm
14	58898600	Cam Gear
15	58898700	Switch Arm A
16	58734600	Switch Arm B (A-Mecha.)
	58898800	Switch Arm B (B-Mecha.)
17	58734700	Switch Arm C
18	58738100	Belt
20	58734900	Nylon Washer (2.6x0.25)
23	58735000	Nylon Washer (2.6x0.5)
25	58735100	Eject Spring (L), (A-Mecha.)
	58898900	Eject Spring (R), (B-Mecha.)
26	58735200	Slide Spring
29	58735300	Flywheel Ass'y (FWD)
30	58738200	Flywheel Ass'y (REV)
31	58735400	Pinch Roller Ass'y (R)
32	58891400	Pinch Roller Ass'y (L)
36	58735500	M2.6x5 Pan. Head Screw
37	58899000	Special Screw
39	58735700	E-type Ring
43	58899100	Holder Cushion
51	58735900	Solenoid Ass'y
52	58736000	Fix Core
53	58736100	Plunger
61	58736200	Plate Hold Ass'y (A-Mecha.)
	58899200	Plate Hold Ass'y (B-Mecha.)
63	58736400	M2.6x4 Pan. Head Screw
66	58899400	Cassette Pocket
68	58736600	Door Spring (A-Mecha.)
	58899500	Door Spring (B-Mecha.)

6. SCHEMATIC DIAGRAM 6-1. REC Amp. Section

Design and specifications subject to changes without notice for improvements.

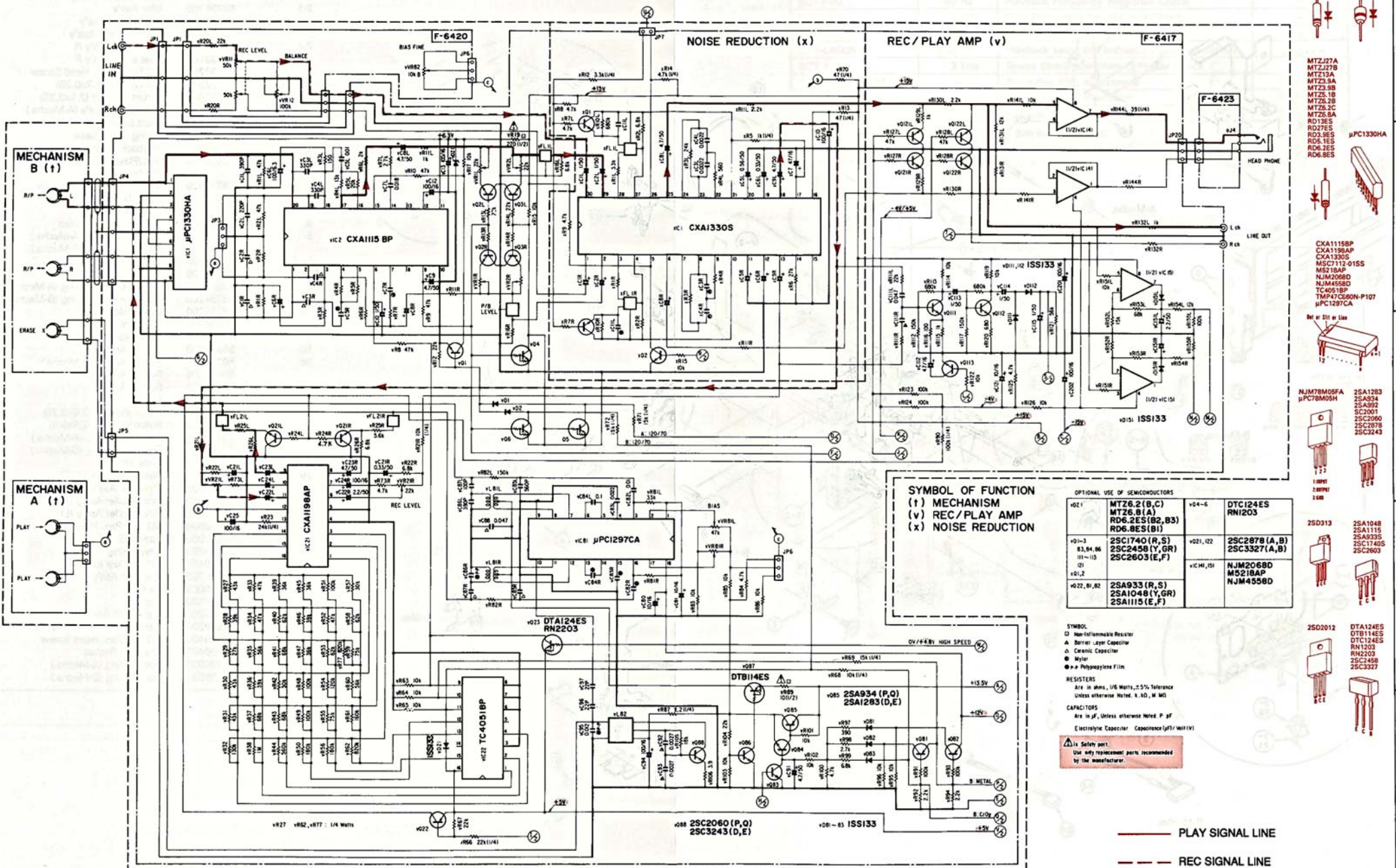

SYMBOL OF FUNCTION
 (t) MECHANISM
 (v) REC/PLAY AMP
 (x) NOISE REDUCTION

OPTIONAL USE OF SEMICONDUCTORS

V02-1	MT26.2(B,C) MT26.8(A) RD6.2ES(B2,B3) RD6.8ES(B1)	V04-6	DTC124ES RN1203
V01-3 83, 84, 86 101-113 121	25C1740(R,S) 25C2458(Y,GR) 25C2603(E,F)	V021, 122	25C2878(A,B) 25C3327(A,B)
V01, 2		VIC4H, IS1	NJM2068D M5218AP NJM4558D
V022, B1, 82	25A933(R,S) 25A1048(Y,GR) 25A1115(E,F)		

SYMBOL
 □ Non-inductance Resistor
 A Barrier Layer Capacitor
 △ Ceramic Capacitor
 ● Mylar
 ⊙ Polypropylene Film

RESISTORS
 Are in ohms, 1/8 Watts, ±5% tolerance
 Unless otherwise noted, 0.10, 0.10 W

CAPACITORS
 Are in μ F, unless otherwise noted. P = pF
 Electrolytic Capacitor Capacitance (μ F) / Volt (V)

**⚠ Safety part.
 Use only replacement parts recommended
 by the manufacturer.**

— PLAY SIGNAL LINE
 - - - REC SIGNAL LINE

- 10E2 11E2
- 15S133
- MT2J27A
- MT2J27B
- MT2J3A
- MT2J9A
- MT2J9B
- MT2J18
- MT2J28
- MT2J2C
- MT2J8A
- RD13ES
- RD27ES
- RD3.9ES
- RD5.1ES
- RD6.1ES
- RD6.8ES
- μ PC1330HA
- CXA1115BP
- CXA1198AP
- CXA1330S
- M5C7112-01SS
- M5218AP
- NJM2068D
- NJM4558D
- TC4051BP
- TMP47C50N-P107
- μ PC1297CA
- Not in S1 in Use
- NJM78M05FA
- μ PC78M05H
- 25A1283
- 25A934
- 25A935
- SC2001
- 25C2060
- 25C2878
- 25C3243
- 25D013
- 25A1048
- 25A1115
- 25A932
- 25C1740S
- 25C2603
- 25D012
- DTA124ES
- DTB114ES
- DTC124ES
- RN1203
- RN2203
- 25C2458
- 25C3327

6-2. Control Section

* Design and specifications subject to changes without notice for improvements.

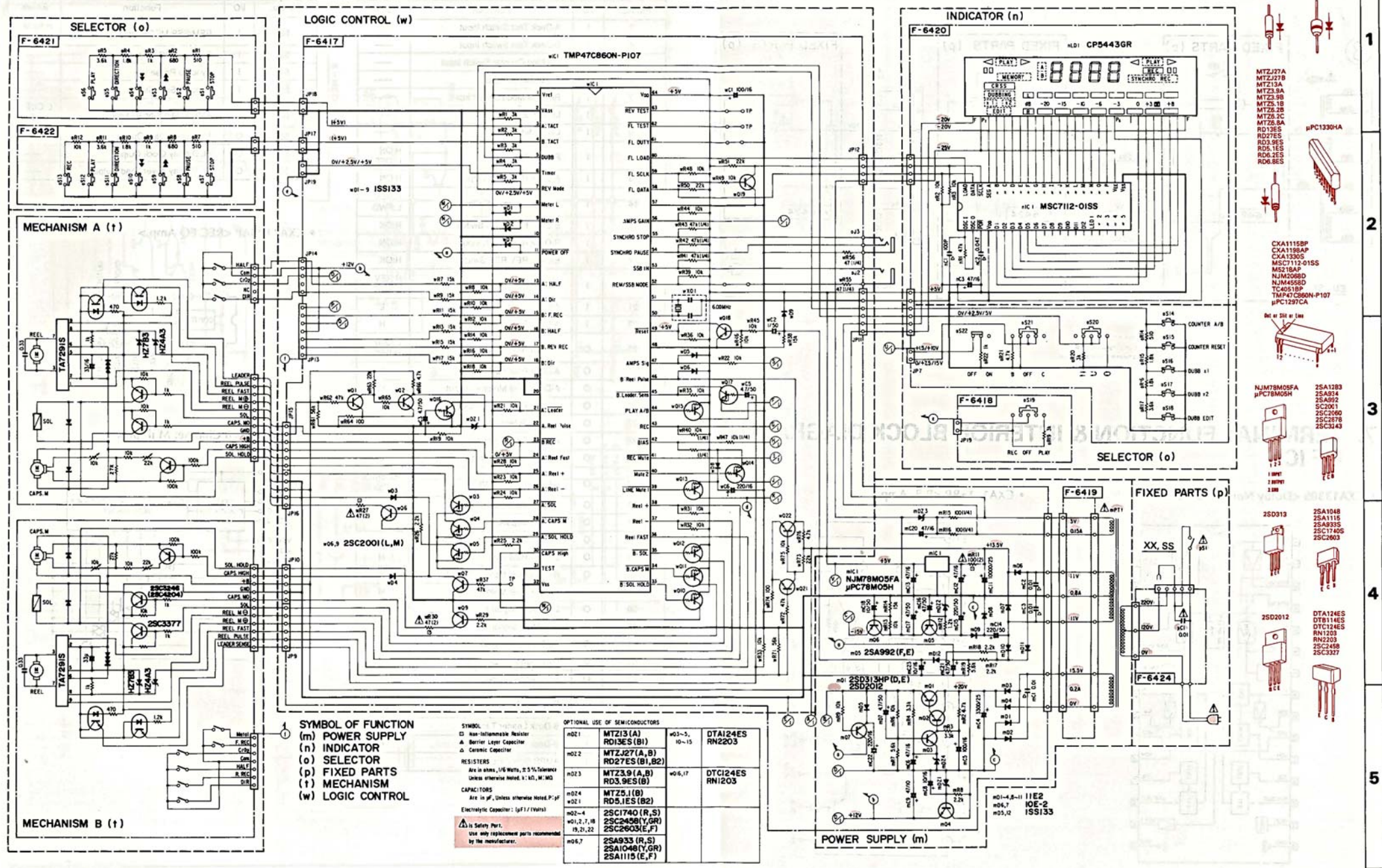

SYMBOL OF FUNCTION
 (a) POWER SUPPLY
 (n) INDICATOR
 (o) SELECTOR
 (p) FIXED PARTS
 (t) MECHANISM
 (w) LOGIC CONTROL

SYMBOL
 □ Non-Inductance Resistor
 ▽ Barrier Layer Capacitor
 ▲ Ceramic Capacitor

RESISTORS
 Are in ohms, 1/16 Watts, 0.5% Tolerance unless otherwise noted. 1, 1k, M, 1M, 10k, 100k, 1M, 10M, 100M, 1G.

CAPACITORS
 Are in μ F, unless otherwise noted. P, μ F, Electrolytic Capacitor: (pF) / (Volts)

⚠ Safety Part.
 Use only replacement parts recommended by the manufacturer.

OPTIONAL USE OF SEMICONDUCTORS			
W021	MTZ13 (A) RD13ES (B1)	W03-5, 10-15	DTA124ES RN2203
W022	MTZJ27 (A, B) RD27ES (B1, B2)		
W023	MTZ3.9 (A, B) RD3.9ES (B)	W06, 17	DTC124ES RN1203
W024	MTZ5.1 (B) RD5.1ES (B2)		
W02-4	2SC1740 (R, S) 2SC2458 (Y, GR) 2SC2603 (E, F)		
W06, 7	2SA933 (R, S) 2SA1046 (Y, GR) 2SA1115 (E, F)		

- 10E2 11E2
- ISS133
- MTZJ27A
- MTZJ27B
- MTZ13A
- MTZ3.9A
- MTZ3.9B
- MTZ5.1B
- MTZ5.1B
- MTZ5.2B
- MTZ5.2C
- MTZ5.2A
- RD13ES
- RD27ES
- RD3.9ES
- RD5.1ES
- RD5.2ES
- RD6.8ES
- μ PC1390-BA
- 25A1283
- 25A514
- 25A922
- 25C2061
- 25C2060
- 25C2576
- 25C3143
- 25A1948
- 25A1116
- 25A933S
- 25C1740S
- 25C2603
- DTA124ES
- DTB114ES
- DTC124ES
- RN1203
- RN2203
- 25C2458
- 25C2327

6-3. Power Supply Section

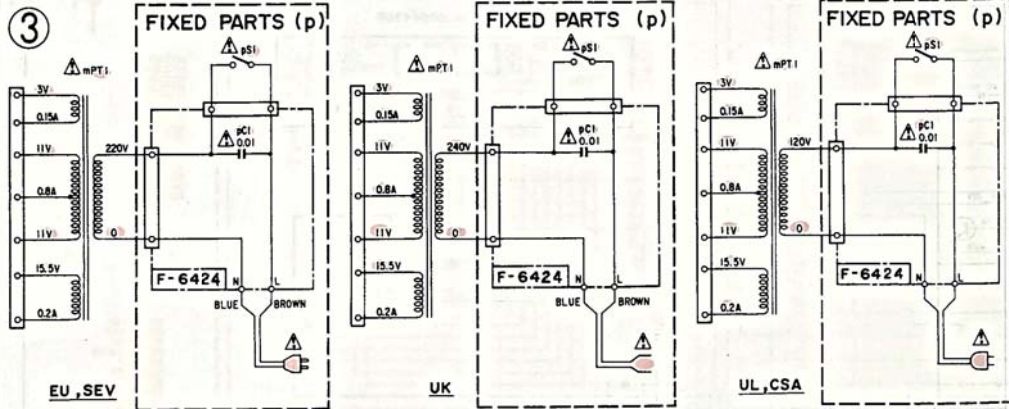

⚠ is Safety Part.
Use only replacement parts recommended by manufacturer

7. TERMINAL FUNCTION & INTERIOR BLOCK DIAGRAM OF ICs

• CXA1330S <Dolby Noise Reduction>

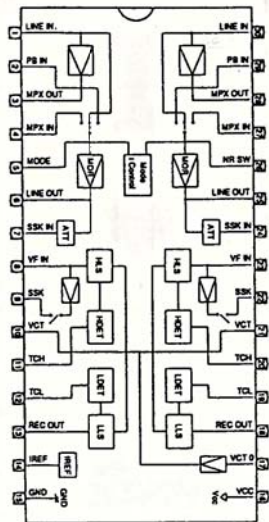

• CXA1115BP <P.B. Amp.>

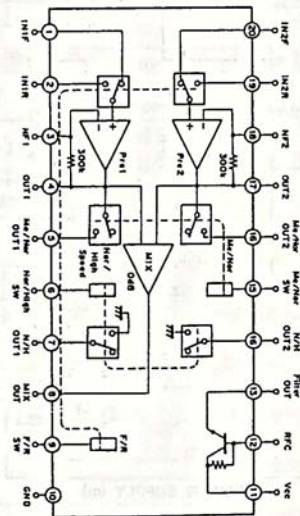

• Terminal Function of TMP47C860N-P107 (Micro computer)

Pin No.	I/O	Function	Active
3	I	A-Deck Tact Switch Input	---
4	I	B-Deck Tact Switch Input	---
5	I	Dubbing Counter Switch Input	---
6	I	Timer Switch Input	---
7	I	Reverse Mode Switch Input	---
8	I	Level Meter (L)	---
9	I	Level Meter (R)	---
11	I	Power off/in	H:ON L:OFF
13	I	A-Deck Half Switch Input	H:ON
14	I	A-Deck Direction Switch	H:REV L:FWD
15	I	B-Deck FWD REC Switch	H:OK
16	I	B-Deck Half Switch Input	H:ON
17	I	B-Deck REV REC Switch	H:OK
18	I	B-Deck REC Output	H:REV L:FWD
21	I	A-Deck Leader Tape in	L
22	I	A-Deck Reel Pulse	H
23	O	B-Deck REC Output	L:Only H:REC
24	O	A-Deck Reel Fast Output	H
25	O	A-Deck Reel Motor + Output	H
26	O	A-Deck Reel Motor - Output	H
27	O	A-Deck Solenoid Signal Output	L
28	O	A-Deck Capstan Motor	L
29	O	A-Deck Solenoid Hold	L
30	O	Capstan Motor High	H:Normal L:High
33	O	B-Deck Solenoid Hold	L
34	O	B-Deck Capstan Motor	L
35	O	B-Deck Solenoid Signal Output	L
36	O	B-Deck Reel Fast	H
37	O	B-Deck Reel Motor - Output	H
38	O	B-Deck Reel Motor + Output	H
39	O	Line Mute Signal 1	H
40	O	Line Mute Signal 2	H
41	O	REC Mute Signal Output	H
42	O	Bias Signal Output	L
43	O	REC Signal Output	H
44	O	Play A/B Signal Output	L:A H:B
45	I	B-Deck Leader Tape in	L
46	I	B-Deck Reel Pulse Input	H
47	I	AMPS Signal Input	L

Pin No.	I/O	Function	Active
52	I	REM/SSB MODE Input	H:REM L:SSB
53	I	Remoon/SSB Input	---
54	I	Synchro Pause in	---
55	I	Synchro Start/Stop in	---
56	O	AMPS Gain Signal Output	L:CUE REVIEW
58	O	FL Display Data Output	---
59	O	FL Display Clock Output	---
60	O	FL Display driver Load Output	---

• CXA1198AP <REC EQ Amp.>

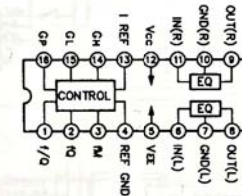

• TC4051BP <8 Channel Multiplex>

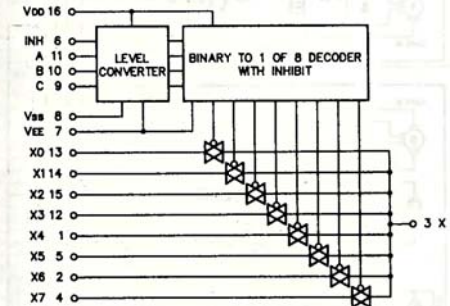

• Terminal Function of MSC7112-01SS
(VF Display Controller)

Pin No.	Part	I/O	Function
4	V _{DD}	—	V _{DD} -V _{SS} Power supply for internal logic.
22	V _{SS}	—	V _{DD} -V _{EE} Power supply for VF drive circuit logic.
23	V _{EE}	—	
41	DATA IN	I	Indication data input of the shift resistor.
40	S CLK	I	Shift clock for the shift resistor. The data is shifted when the SCLK is tuned off.
42	LOAD	I	Latch clock of the indication data. The data is throughput at the "H" level of the LOAD, and the data just before the "H" level is latched at the "L" level.

Pin No.	Part	I/O	Function
3	POR	I	Reset input terminal for the internal logic when turning on the power supply.
1	OSC I	I	Oscillation circuit input terminal.
2	OSC O	O	Oscillation circuit output terminal.
24~39	SEG A~P	O	VF indication tube drive output.
5~16	D1~D12	O	VF light indication tube drive output.
17~21	LED 1~LED 5	O	LED drive output.

• μPC1330HA <Selector>

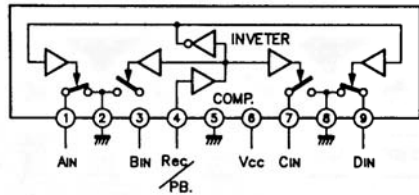

• μPC1297CA <Dolby HX PRO>

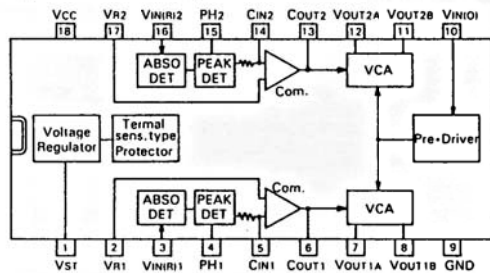

• Terminal Function <μPC1297CA>

Pin No.	Pin Name	Terminal Function
1	V _{ST}	Input terminal for standard supply voltage.
2	V _{R1}	Input terminal for standard voltage of comparator.
3	V _{INIR1}	Input terminal for rec signal.
4	PH1	Terminal to connect a capacitor for peak hold.
5	CIN1	Input terminal for comparator.
6	COUT1	Output terminal of comparator.
7	V _{OUT1A}	Output terminal of VCA1A.
8	V _{OUT1B}	Output terminal of VCA1B.
9	GND	Ground terminal.
10	V _{IN IO}	Input terminal for bias signal.
11	V _{OUT2B}	Output terminal of VCA2B.
12	V _{OUT2A}	Output terminal of VCA2A.
13	COUT2	Output terminal of comparator.
14	CIN2	Input terminal for comparator.
15	PH2	Terminal to connect a capacitor for peak hold.
16	V _{INIR2}	Input terminal for rec signal.
17	V _{R2}	Input terminal for standard voltage of comparator.
18	V _{CC}	Power supply voltage terminal.

8. OTHER PARTS

<Front View>

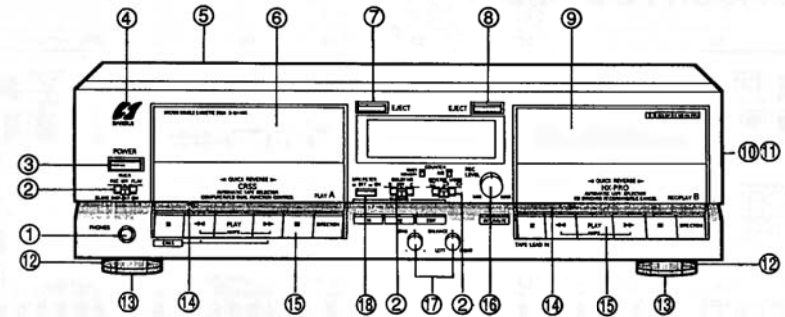

<Top View>

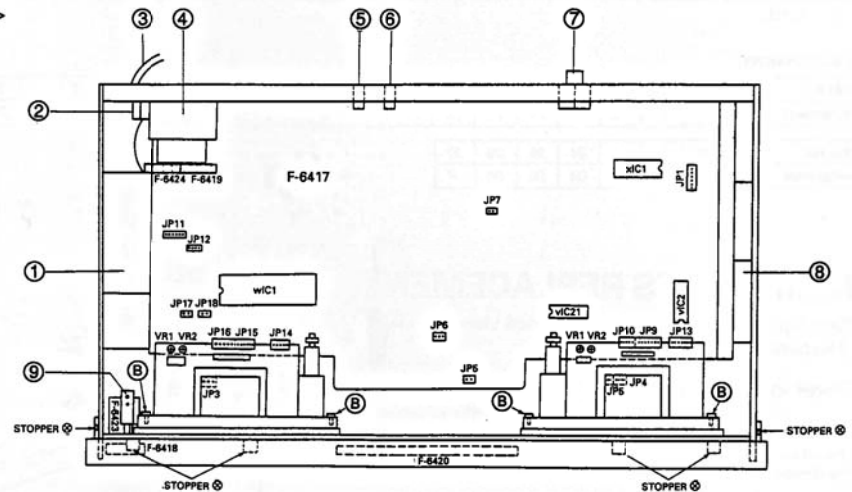

Parts List <Front View>

Parts No.	Stock No.	Description
1	49495100	Headphone Jack
2	05004300	Slide Knob, TIMER-DOLBY REVERSE MODE
3	27626500	Power SW. Knob
4	27833310	Logo Badge
5	27835400	Bonnet
6	05005200	Lid Cover A
7	05004900	Eject Knob A
8	05005000	Eject Knob B
9	05005300	Lid Cover B
10	05006300	Front Panel A
11	05004000	Front Panel B (Plastic)
12	27857010	Ring for Leg
13	27842000	Leg Sheet
14	05005100	Azimuth Cover
15	05004100	Control Knob
16	05004500	Knob, REC LEVEL
17	05004400	Knob, BALANCE-BIAS
18	05004200	Knob, MPX FILTER

Parts List (Top View)

Parts No.	Stock No.	Description
1	27820720	Channel, Left
2	47157300	AC Cord Cover
Δ 3	38004700	Power Supply Cord (XX, UL, CSA)
Δ	48837700	Power Supply Cord (SS)
Δ	49252900	Power Supply Cord (UK)
Δ	49299300	Power Supply Cord (EU, SEV)
Δ 4	15038301	Power Transformer (XX, SS)
Δ	15038302	Power Transformer (UL, CSA)
Δ	15038305	Power Transformer (EU, SEV)
Δ	15038306	Power Transformer (UK)
5	48985400	Jack, System Control
6	49436400	Jack, Synchro REC
7	48528500	4P Terminal, LINE IN/OUT
8	27820830	Channel, Right
Δ 9	46364300	Push SW., POWER

9. DISPLAY PATTERN AND PIN ASSIGNMENT OF CP5443GR FL DISPLAY

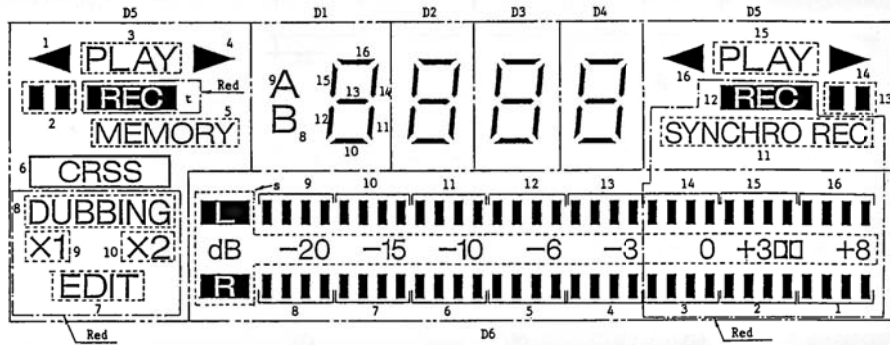

PIN ASSIGNMENT

Pin No.	1	2	3	4	5	6	7	8	9	10	11	12	13	14	15	16	17	18	19
Assignment	F	Pt	P1	P2	P3	P4	P5	P6	P7	P8	P9	P10	P11	P12	P13	P14	P15	P16	Ps

Pin No.	20	21	22	23	24	25	26	27
Assignment	NC	D1	D2	D3	D4	D5	D6	F

F: Filament NC: No Connection

10. MAIN PARTS REPLACEMENT

(See Top View on page 14 and Exploded View of Mechanism on page 10)

A. Lid Cover (A) and (B) (See Fig. 10-1)

- 1) Press the eject knob and open the lid cover.
- 2) Lift up lock (A) and lock (B) (arrow mark (D)) to unlock the cassette pocket (C).
- 3) Position the lid cover horizontally in the direction of the arrow mark (E).
- 4) Push in the direction of the arrow mark (F) and lift up to remove the cover.

B. Azimuth Cover

Insert a screwdriver in the groove of the azimuth cover (G) center and remove the hook. (See Fig. 10-2.)

C. Mechanism Assembly

- 1) Remove the bonnet.
- 2) Remove the bottom plate.
- 3) Press the eject knob to open the cassette pocket and remove lid cover (A) and (B) (See Fig. 10-1).
- 4) Disconnect JP3, JP14, JP15 and JP16.
- 5) Disconnect JP7, JP11 and JP12 (A-mechanism only).
- 6) Remove the six stoppers (H). Slide the front panel assembly forward.
- 7) Remove the 4 screws (I) attaching the mechanism assembly.
- 8) Remove the mechanism assembly from the backside, passing through the bottom of the front panel assembly with the cassette pocket (C) kept open (See Fig. 10-3).

D. Front panel assembly (A) or (B)

- 1) Remove the mechanism assembly.
- 2) Pull out the REC LEVEL, BIAS AND BALANCE knobs.
- 3) Remove two screws to remove the power switch and power knob.
- 4) Remove one screw to remove TIME board F-6418.

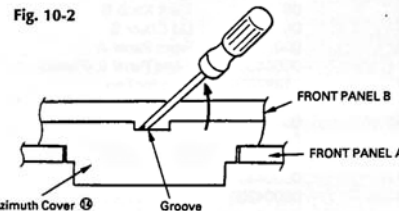
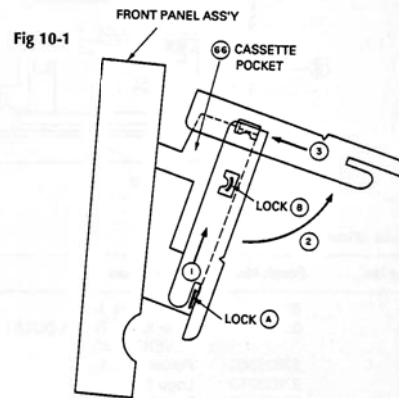

- 5) Disconnect JP1, JP17 and JP18.
- 6) Disconnect parallel cord JP6.
- 7) Unhook two stoppers to remove phone board F-6423.
- 8) To separate front panel assembly (A) and (B), unhook all stoppers while pushing front panel assembly (B) in the direction of arrow B. (See Fig. 10-4.)
- 9) Remove two screws, two stoppers and three nuts to remove F-6420.

E. Head Base Ass'y (J)

(See Exploded View of Mechanism on Page 10)

- 1) Remove the mechanism ass'y from the set.
- 2) Remove the cassette pocket (C).
- 3) Remove the pinch roller F (K) and R (L) ass'y.
- 4) Remove the special screw (M) fixing the eject stopper (N).
- 5) Remove the head base spring (O).
- 6) Disconnect the soldered Q5 lead wire (P).
- 7) Unhook the lead holder (Q) from the mechanism chassis.
- 8) Remove the head base ass'y (J) from the mechanism chassis.

F. Cam Gear (R), Belt (S), Flywheel Ass'y (T), (U)

(See Exploded View of Mechanism on Page 10)

- 1) Remove the three screws (V) fixing the capstan motor ass'y (W).
- 2) Disconnect two soldered lead wire connected to the P.C.B. (control) (X) and the capstan motor ass'y (W).
- 3) Remove the belt (S).
- 4) Remove the flywheel F ass'y (T) and R ass'y (U).
- 5) Remove the play arm (Y).
- 6) Remove the P.C.B (Direction SW.) (Z).
- 7) Move the slide plate (AA) to the right until it stops and remove it together with the cam gear (R).

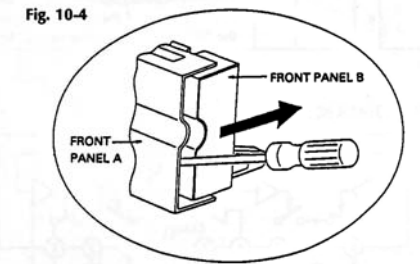
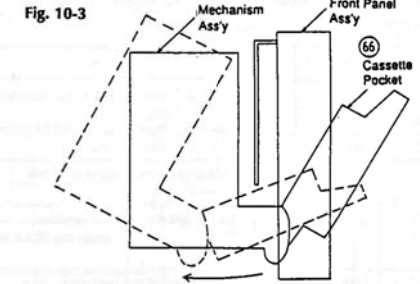

11. PACKING LIST

Parts No.	Stock No.	Description
1	47859100	Vinyl Bag
2	27831600	Styrofoam Packing, R-CH
3	27831500	Styrofoam Packing, L-CH
4	05009400	Carton Case

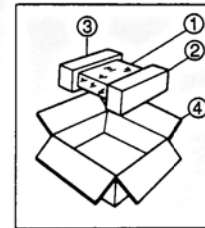

12. ACCESSORY LIST

Parts No.	Stock No.	Description
	48802100	PJP Cord, 1m
	46267300	Mini Pin Plug Cord
	19066800	Operating Instructions



SANSUI ELECTRIC CO., LTD.:

SANSUI USA INC.:

SANSUI DEUTSCHLAND G.M.B.H.:

山水電気株式会社

New River Bldg. 10-14, Shinkawa 1-chome, Chuo-ku, Tokyo 104, Japan
 PHONE: (03) 5586-1024 / FAX: 03-5586-1027 (International Division)
 1250 Valley Brook Ave. Lyndhurst, N.J. 07071 U.S.A.
 17150 South Mergay Ave. Carson, California 90746 U.S.A.
 Paul-Ehrlich-Strasse 8, 6074 Rödermark 2, West Germany

東京都中央区新川1-10-14 (〒104)

(SM2-192) Printed in Japan (1990.09.C) <Stock No. 36553500>